

Work Clamp 60mm

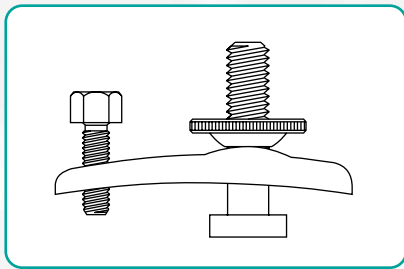

Size	Code	Price
60mm	WC 60	£15.33

Clamp Part

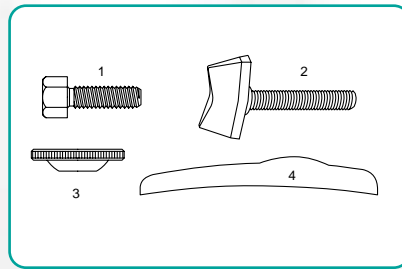

Part No.	Code	Price
1	WCS 60	£3.33
2	WC-5100	£2.05
3	WC-N100	£2.60
4	WCC 60	£4.50

Tee Bolts

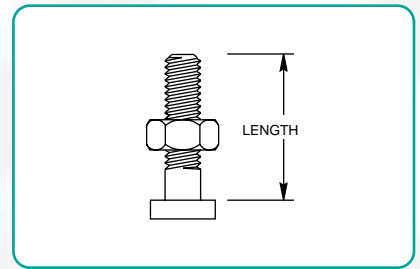

Length	Code	Price
35mm	WC-TB 35	£4.20
65mm	WC-TB 65	£5.25
100mm	WC-TB 100	£7.35

Work Clamp 100mm

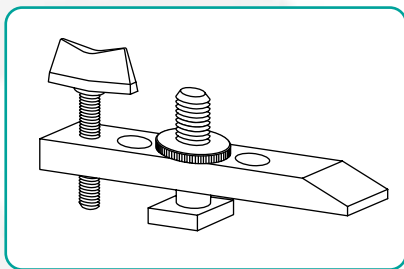

Size	Code	Price
100mm	WC 100	£15.33

Work Clamp for Grand T Slot Table

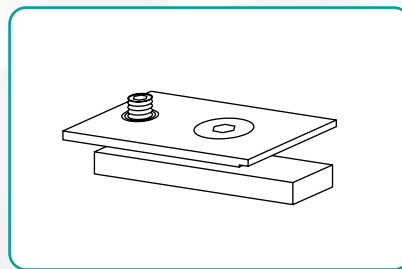

Type	Code	Price
Steel	WC-GT42	£15.33

Work Clamp for IS400

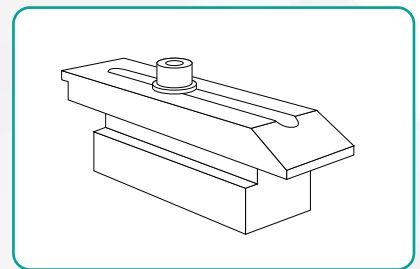

Type	Code	Price
Aluminium	WC 65	£14.18

Table Fences

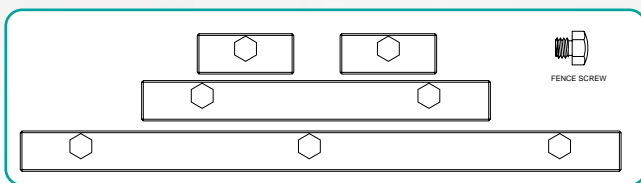

Length	Code	Price
38mm	TF 38	£5.25
150mm	TF 150	£11.55
230mm	TF 230	£14.80

Table fence screws	TFS	£1.26
--------------------	-----	-------

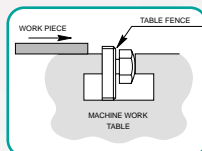

Copy Clamps

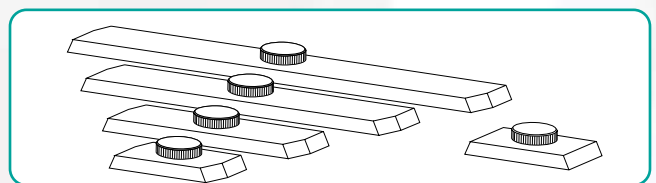

Product	Size	Code	Price
Quick Release Clamps	1 1/4"	CC-QR1250	£5.78
Quick Release Clamps	2 1/4"	CC-QR2250	£7.35
Quick Release Clamps	3 1/2"	CC-QR3500	£8.93
Quick Release Clamps	4 1/2"	CC-QR4500	£10.50
Standard Clamps	1 1/4"	CC-S1250	£5.78
Standard Clamps	2 1/4"	CC-S2250	£7.35
Gravograph, Kanto, etc	31.75mm	CC-S3175	£5.78
Copy Clamp Screws		CC-CS	£1.37

G Clamps

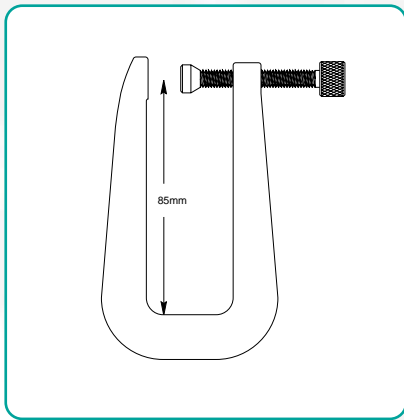

Light duty deep throat 'G' Clamp.
Ideal for clamping masters etc on to copy tables

Code	Price
WC-DTGS	£16.00

Allen Keys

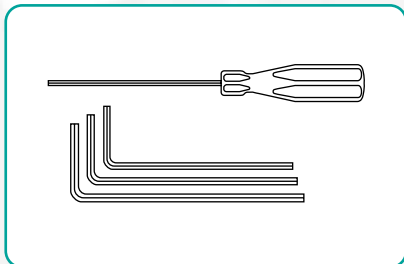

A complete range of allen keys and allen Drivers are held in stock.

Toggle Clamp

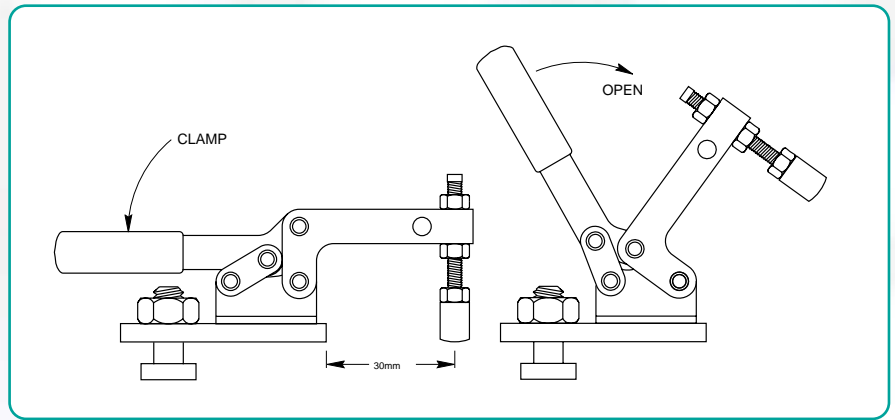

Product	Size	Code	Price
Toggle Clamps	110mm	WC-T110	£23.10